

GF Series - 3 Pole+N, 100 mA 480Y/277V AC Ground Fault Sensing and Relaying Device (RCCB)

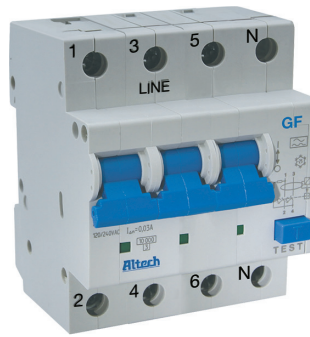

The GF Series of Equipment Ground Fault Protection Relays (Earth Leakage Protection) is the latest addition to Altech's UL Listed product range, providing ground fault (residual current) protection for circuits with loads up to 63A. Short Circuit Withstand rating is 10kA.



Ordering Information

Rated Current	Type/ Cat. No.	Rated Voltage
25A	GF425100	480Y/277V AC
40A	GF440100	480Y/277V AC
63A	GF463100	480Y/277V AC

UL 1053
Ground Fault Sensing
and Relaying Device

Technical Specification

Number of Poles	3+N
Voltage Rating (maximum)	480Y/277V AC
Ground Fault Sensitivity Level	100mA
Rated Frequency	50/60Hz
Cable Size & Tightening Torque	Stranded Wire: 16 - 3 AWG (1.5 mm ² - 25 mm ²) @ 17.5 lb-in (2.0 Nm) 16 - 10 AWG (1.5 mm ² - 5.5 mm ²) @ 17.5 lb-in (2.0 Nm) 18 - 16 AWG (1 mm ² - 1.5 mm ²) @ 25 lb-in (2.8 Nm)
Electrical Life	6000 Switching Operations
Mechanical Life	10000 Switching Operations

Dimensions
(to convert to inches multiply by 0.03937)

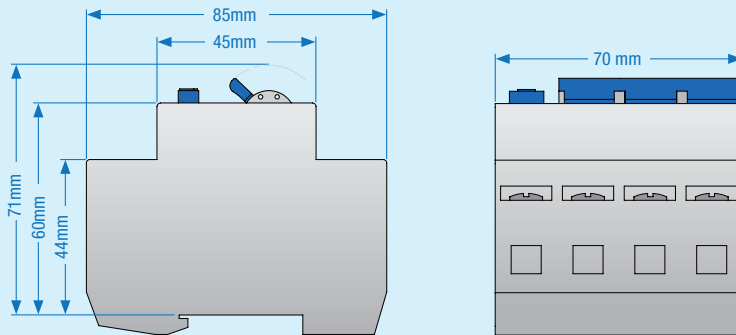

Weight 449 g

GF Series RCCB Ground Fault Trip Curve

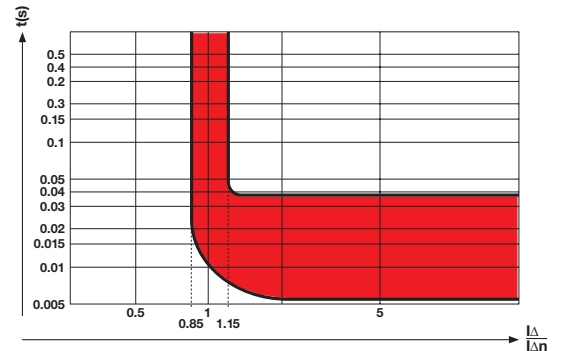

GF Series RCCB Short Circuit Withstand Rating

V	IR	Backup
3+N Pole 480Y/277V AC	10kA	Class J Fuse 250A or lower Altech L Series Branch Circuit Breaker Altech R Series Supplementary Protector

GF Series - 3 Pole+N, 100 mA
 Applicable voltage systems and wiring examples.

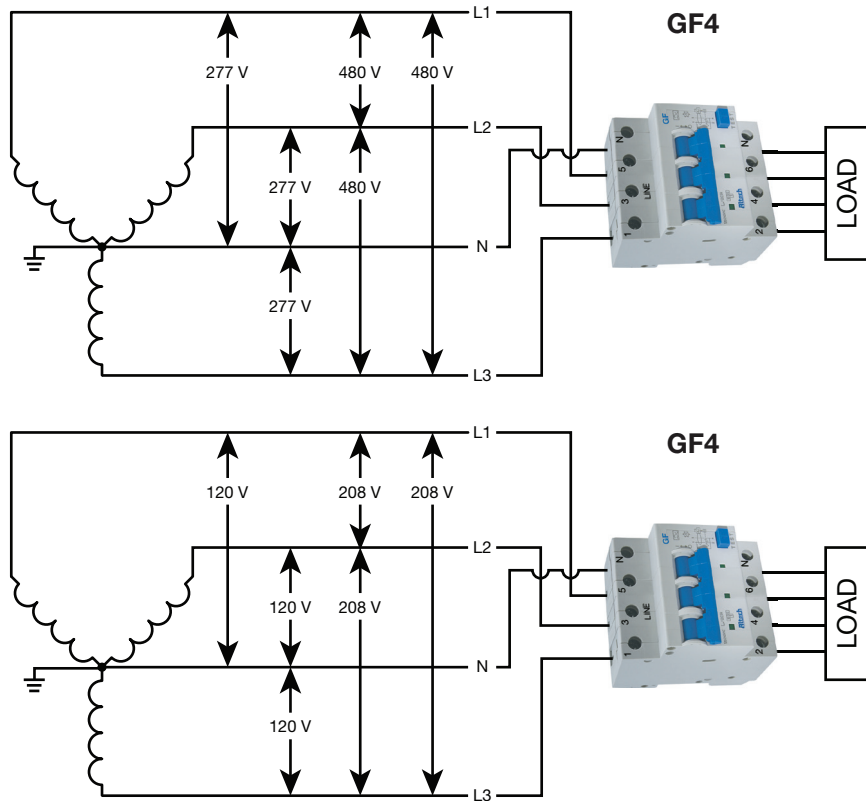

UL 1053
 Ground Fault Sensing
 and Relaying Device

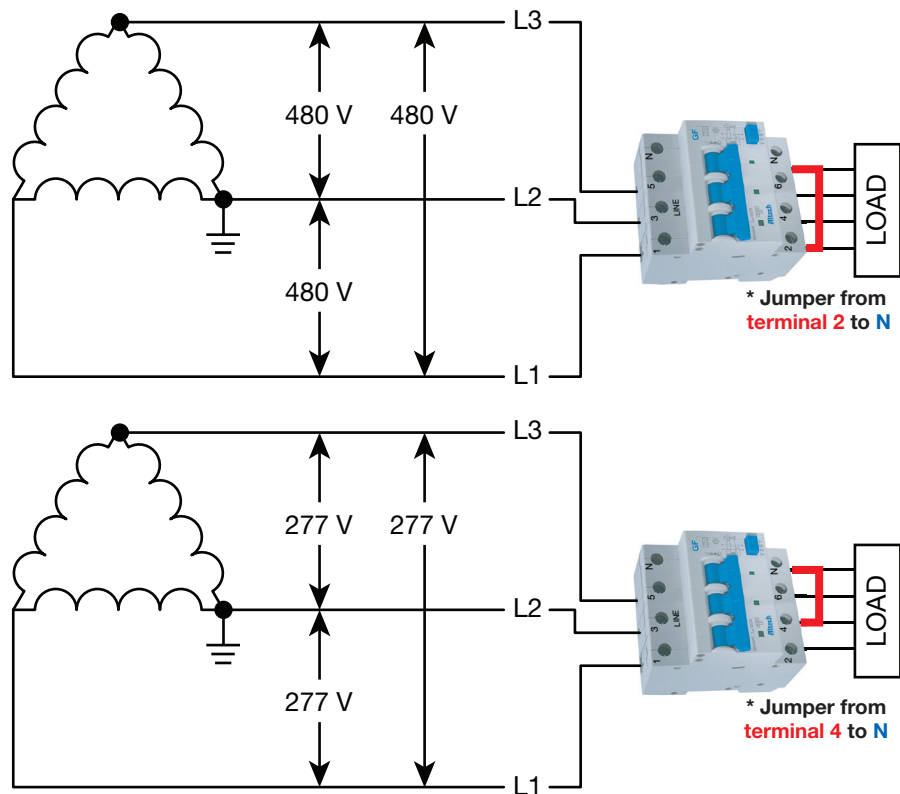
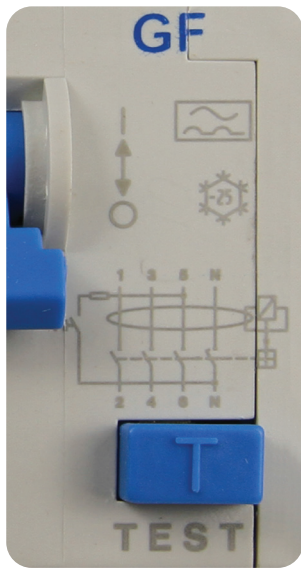

* Either jumper connection can be used for both voltage configurations.